

# SERBATOI OLIO SOTTOCASSA UNDER-BODY OIL TANKS

Tipo / Type  
**Fam. EASY-04 (200x370)**  
CAPACITÀ SERBATOIO Lt  
TANK CAPACITY Lt **35**

Serbatoi in acciaio con testate imbutite, verniciati a finire con polvere epossidica grigia (Ral 7021).  
Provvisi di: tappo di riempimento ventilato, supporti saldati per il fissaggio a telaio, flangia per alloggiamento filtro ritorno e spia livello olio.

Steel tank with deep-drawn heads, final coated with grey epoxy powder (Ral 7021).

Equipped with: breather filler cap, welded supports for chassis fitting, return filter flange and oil level warning.

Capacità fino a livello olio  
Capacity until oil level indicator 26 lt \*

**H1GS0405260**



Peso/Weight 13,5 Kg

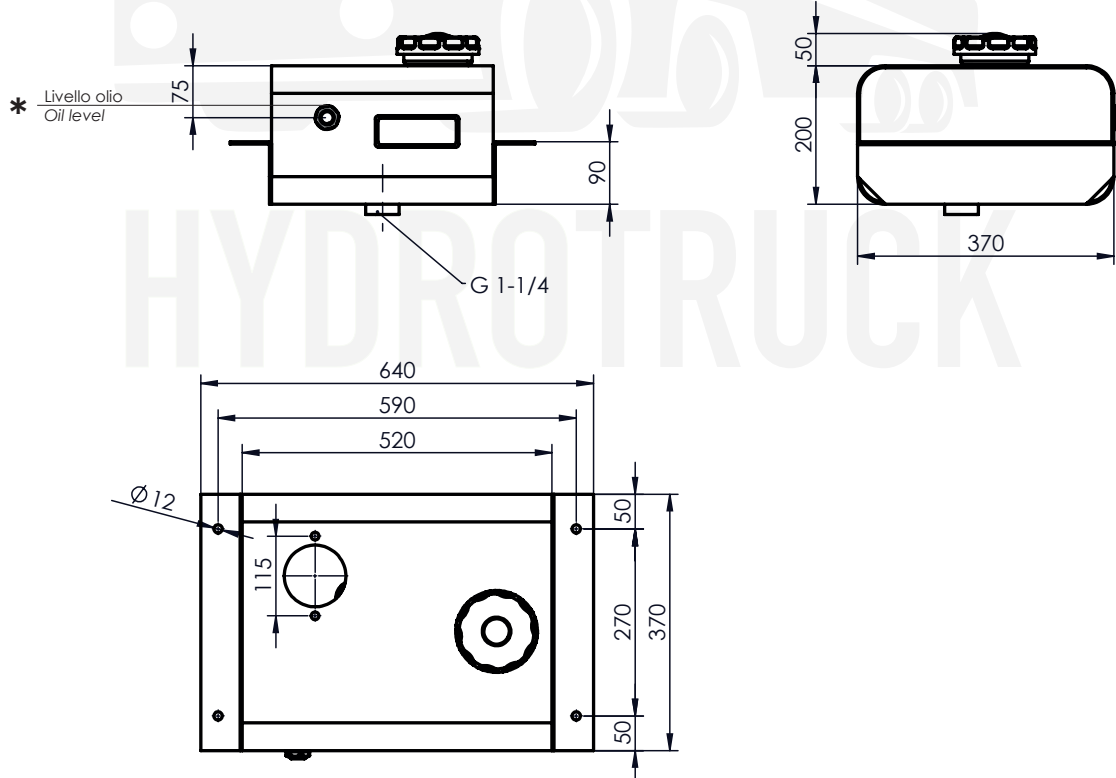

**11801300201 : TAPPO DI RIEMPIMENTO / FILLER CAP**  
Già compreso nel kit di fissaggio. Solo per ricambi  
Already included in the fixing kit. Only for spare part



**50900400123: LIVELLO OLIO / OIL LEVEL**  
Già compreso nel serbatoio. Solo per ricambi  
Already included with the tank. Only for spare part



AUTORIZZOVANÝ PRODEJCE

[www.hydrotruck-nadrze.cz](http://www.hydrotruck-nadrze.cz)  
[info@hydrotruck.cz](mailto:info@hydrotruck.cz)

Hydrotruck s.r.o.  
Tovačovská 3457/4a  
750 02, Přeřov  
Česká republika

pag.49

**Piastra di chiusura cieca. Blank flange.**

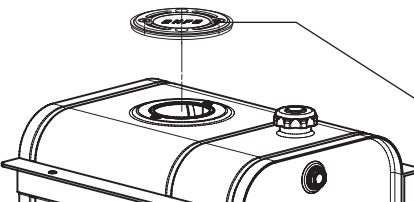
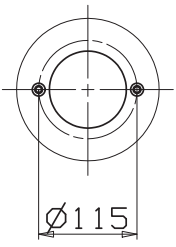
	<p>Piastra di chiusura cieca Blank flange (vedi tabella 6 - see table 6)</p>		<p>135-990-20110</p>
---	--	---	----------------------

**Filtro e piastra di chiusura predisposta per il montaggio della valvola.**

Filter and mounting flange for tipping valve.

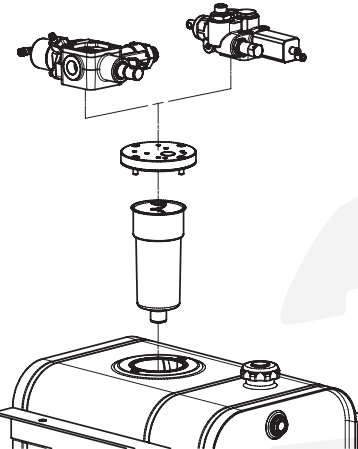
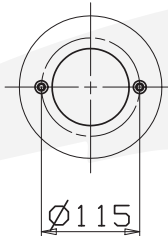
		<p><b>VALVOLA VALVE</b></p>	<p>FM / FP 80 Modular 150 AL</p>	<p><b>PIASTRA PER VALVOLA VALVE MOUNTING PLATE</b></p>	<p>121-994-00182 (vedi tabella 7 - see table 7)</p>
		<p><b>FILTRO FILTER</b></p>	<p>118-001-12158 118-001-11159</p>	<p>30 µm 60 µm</p>	<p>Filtri immersi Submerged filters (vedi tabella 4 - see table 4)</p>

**Filtro flangiato senza possibilità di montare valvole.**

Filter without mounting flange for tipping valves.

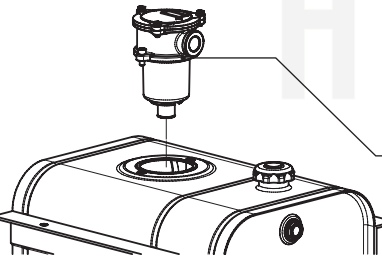
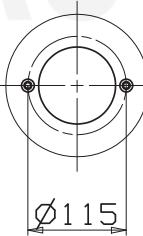
	<p>Filtro flangiato Flangible filter (vedi tabella 2 see table 2)</p>		<p>Acciaio / Steel 90 µm Acciaio / Steel 60 µm Cellulosa rinforzata Reinforced cellulose 25 µm Cellulosa rinforzata Reinforced cellulose 10 µm Microfibra Micro-fibre glass 25 µm</p>	<p>90 L 85 L 75 L 55 L 55 L</p>	<p>118-001-00358 118-001-01357 118-001-02356 118-001-03355 118-001-04354</p>
				<p>105 L 100 L 100 L 75 L 75 L</p>	<p>118-001-00401 118-001-01400 118-001-02418 118-001-03408 118-001-04407</p>