

**PAM-TS** **NEW!**

**POMPA A MANO CON RUBINETTO DI SCARICO**  
**HAND PUMP WITH LOWERING VALVE**

**PREDISPOSTA PER SERBATOIO**  
**SUITABLE FOR OIL TANK**

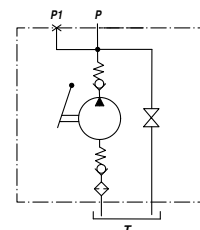
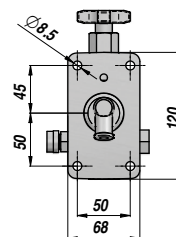
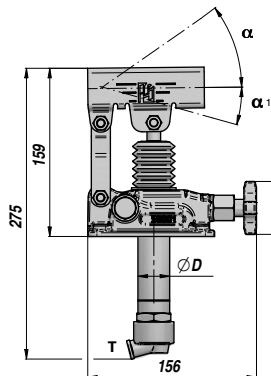
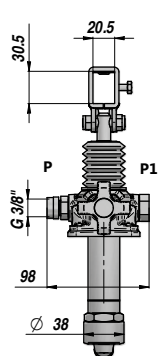
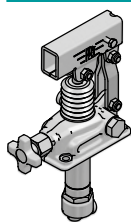

Codice Code	Tipo Type	cm3/ciclo cm3/cycle	P MAX bar	ØD	α	α <sub>1</sub>	Temperatura d'esercizio Working Temperature	kg
PAM0141202	PAM-TS 12	12	380	30	37°	13°		2,89
PAM0142502	PAM-TS 25	25	350	35	57°	15°	-20°C +80°C	2,99
PAM0144502	PAM-TS 45	42	280	40	52°	28°		3,12

Funzionamento D.E. per cilindro S.E. - Double-stroke for a S.A. cylinder

A RICHIESTA - ON REQUEST:

PAMX-TS = POMPA CON SUPPORTO PER LEVA TONDA - HAND PUMP WITH ROUND LEVER HOLDER

FPM = GUARNIZIONI IN VITON - VITON SEALS

VMQ = GUARNIZIONI IN SILICONE - FLUORINE-SILICONE SEALS

La pompa viene fornita completa di viti di fissaggio e guarnizione NBR. - Hand Pump is supplied with fastening screws and NBR seal.

**LEVE - LEVERS**

Codice Code	Dimensioni Sizes	TYPE	kg
* PAM0290000	20 x 30 x 600	1	0,71
PAM0290900	20 x 30 x 900	1	1,41
PAM0291000	20 x 30 x 1000	1	1,55
PM00290100	Ø27 x 600 ( PAMX )	2	0,91

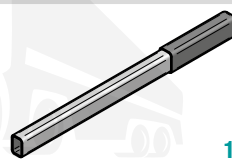

1

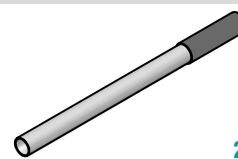

2

\* LEVA STANDARD - STANDARD HAND LEVER

**KIT RICAMBI - SPARE PARTS**

Codice Code	Descrizione Description	Per Pompa For Pump	N°
PAMJVS1245	Kit valvola di scarico Lowering valve kit	All type	1
PAMJV01200	Kit aspirazione Suction valve kit	PAM-TS 12	2
PAMJV02500		PAM-TS 25	
PAMJV04500		PAM-TS 45	
PAMJRA1245	Kit raccordo aspirazione con filtro Suction adapter kit with filter	All type	3
PAMJB01245	Kit bielle Conrod kit	All type	4
PAMJ010001	Supporto leva Hand lever holder	All type	5
PAMJPS1200	Kit pistone+stelo Rod Piston assembled kit	PAM-TS 12	6
PAMJPS2025		PAM-TS 25	
PAMJPS4045		PAM-TS 45	
PAMJ020015	Soffietto Bellow	All type	7
PAMGT00012	Kit guarnizioni standard Standard seal kits	PAM-TS 12	8
PAMGT00025		PAM-TS 25	
PAMGT00045		PAM-TS 45	
PAMJ030017	Guarnizione NBR + viti NBR seal + screws	All type	9

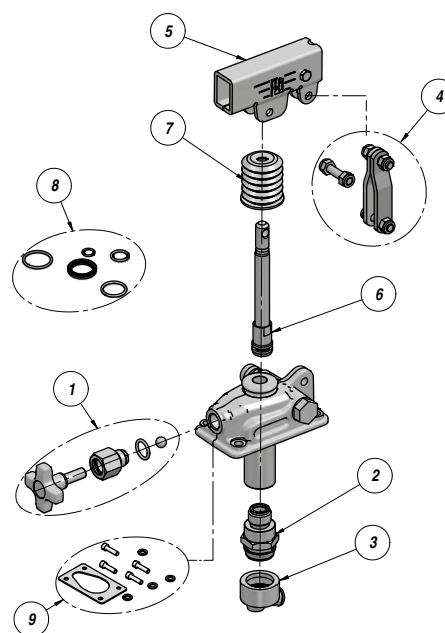

[www.hydrotruck.cz](http://www.hydrotruck.cz)  
[info@hydrotruck.cz](mailto:info@hydrotruck.cz)

Hydrotruck s.r.o.  
Tovačovská 3457/4a  
750 02, Přerov  
Česká republika