

**POMPA A MANO CON RUBINETTO DI SCARICO E V.M.P.
HAND PUMP WITH LOWERING VALVE AND RELIEF VALVE**

NEW!

PAM-TSV

**PREDISPOSTA PER SERBATOIO
SUITABLE FOR OIL TANK**

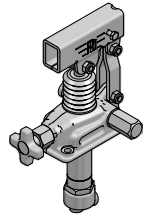
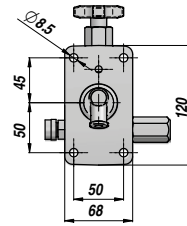
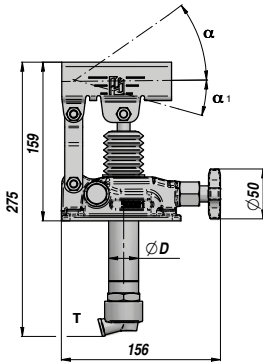
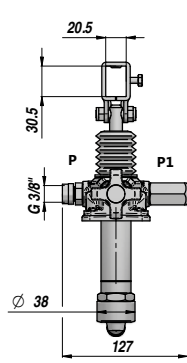
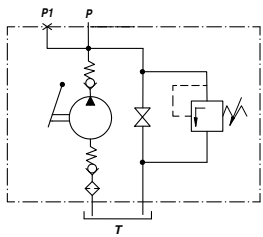

Code Code	Typo Type	cm3/ciclo cm3/cycle	P MAX bar	ØD	α	α ₁	Temperatura d'esercizio Working Temperature	kg
PAM0141203	PAM-TSV dx 12	12	380	30	37°	13°		2,97
PAM0142503	PAM-TSV dx 25	25	350	35	57°	15°	-20°C +80°C	3,07
PAM0144503	PAM-TSV dx 45	42	280	40	52°	28°		3,20

Funzionamento D.E. per cilindro S.E. - Double-stroke for a S.A. cylinder

A RICHIESTA - ON REQUEST:

PAMX-TSV = POMPA CON SUPPORTO PER LEVA TONDA - HAND PUMP WITH ROUND LEVER HOLDER

FPM = GUARNIZIONI IN VITON - VITON SEALS

VMQ = GUARNIZIONI IN SILICONE - FLUORINE-SILICONE SEALS

La pompa viene fornita completa di viti di fissaggio e guarnizione NBR. - Hand Pump is supplied with fastening screws and NBR seal.

LEVA - LEVERS

Code Code	Dimensioni Sizes	TYPE	kg
* PAM0290000	20 x 30 x 600	1	0,71
PAM0290900	20 x 30 x 900	1	1,41
PAM0291000	20 x 30 x 1000	1	1,55
PM00290100	Ø27 x 600 (PAMX)	2	0,91

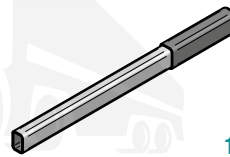

1

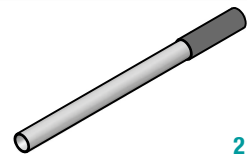

2

* LEVA STANDARD - STANDARD HAND LEVER

KIT RICAMBI - SPARE PARTS

Code Code	Descrizione Description	Per Pompa For Pump	N°
PAMJVS1245	Kit valvola di scarico Lowering valve kit	All type	1
PAMJVMP000	Kit VMP Relief Valve Kit	All type	2
PAMJV01200 PAMJV02500 PAMJV04500	Kit aspirazione Suction valve kit	PAM-TSV 12 PAM-TSV 25 PAM-TSV 45	3
PAMJRA1245	Kit raccordo aspirazione con filtro Suction adapter kit with filter	All type	4
PAMJB01245	Kit bielle Conrod kit	All type	5
PAMJ010001	Supporto leva Hand lever holder	All type	6
PAMJPS1200 PAMJPS2025 PAMJPS4045	Kit pistone+stelo Rod Piston assembled kit	PAM-TSV 12 PAM-TSV 25 PAM-TSV 45	7
PAMJ020015	Soffietto Bellow	All type	8
PAMGT00012 PAMGT00025 PAMGT00045	Kit guarnizioni standard Standard seal kits	PAM-TSV 12 PAM-TSV 25 PAM-TSV 45	9
PAMJ030017	Guarnizione NBR + viti NBR seal + screws	All type	10

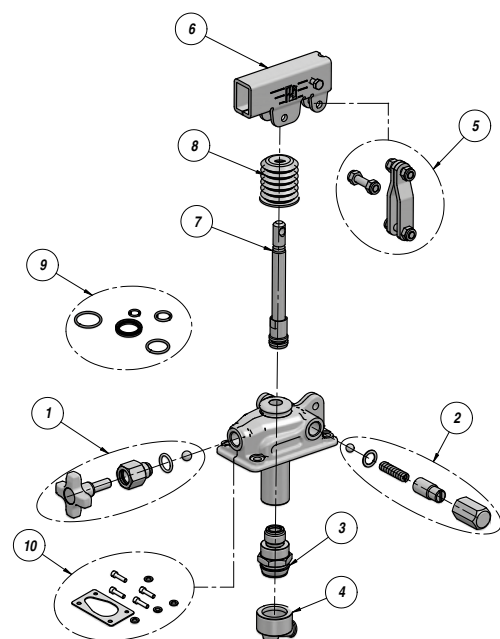

www.hydrotruck.cz
info@hydrotruck.cz

Hydrotruck s.r.o.
Tovačovská 3457/4a
750 02, Přerov
Česká republika